

MX2 manual

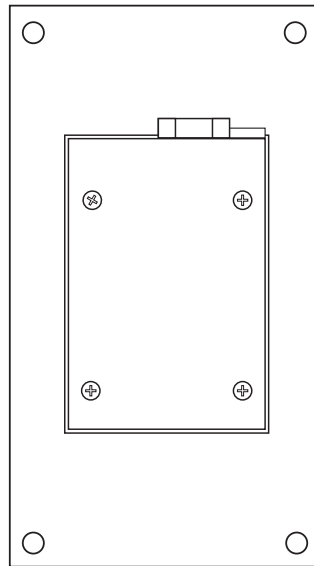
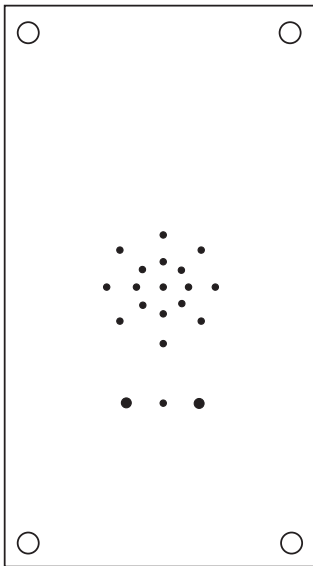

Technical data

Power:	Supply voltage: 10 - 30V DC Current consumption max 50 mA
Emergency signal button:	Can be set as NO or NC, 10-30V DC
Auxillary input:	Can be set as NO or NC, 10-30V DC
Size HxWxD:	130x78x18mm

Content

General information	4
Overview	5
Components	5
Measurements and components list	6
Installation	7
Wiring diagram	7
Wiring diagram - PSTN LINE (Max 9 units)	8
Configuration	9
Configuration overviews	9
Configuration method	11
Configuration Unit numbers	12
Configuration examples	13
Parameter list	15
Operation	19
LED indication for pictogram in car	19
Testing	20
Emergency calling process	21
Troubleshooting	22
Declaration of Conformity	23

General information

This unit was built with state-of-the-art technology and to generally recognised safety related technical standards currently applicable. These installation instructions are to be followed by all people working with the unit, in both installation and maintenance.

It is extremely important that these installation instructions are made available at all times to the relevant technicians, engineers or servicing and maintenance personnel. The basis prerequisite for safe handling and trouble free operation of this system is a sound knowledge of the basic and special safety regulations concerning conveyor technology, and elevators in particular. The unit may only be used for its intended purpose. Note in particular that, no unauthorised changes or additions may be made inside the unit or individual components.

Exclusion of liability

The manufacturer is not liable with respect to the buyer of this product or to third parties for damage, loss, costs or work incurred as a result of accidents, misuse of the product, incorrect installation or illegal changes, repairs or additions. Claims under warranty are likewise excluded in such cases. The technical data is the latest available. The manufacturer accepts no liability arising from printing errors, mistakes or changes.

Declaration of conformity

Download "The declaration of conformity" at our website: www.safeline-group.com

Safety Precautions!

- Only trained professionals, who are authorised to work on the equipment, should install and configure this product.
- This quality product is dedicated for the lift industry. It has been designed and manufactured to be used for its specified purpose only. If it is to be used for any other purpose, SafeLine must be contacted in advance.
- It should not be modified or altered in any way, and should only be installed and configured strictly following the procedures described in this manual.
- All applicable health and safety requirements and equipment standards should be considered and strictly adhered to when installing and configuring this product.
- After installation and configuration this product and the operation of the equipment should be fully tested to ensure correct operation before the equipment is returned to normal use.

Electrical and electronic products may contain materials, parts and units that can be dangerous for the environment and human health. Please inform yourself about the local rules and disposal collection system for electrical and electronic products. The correct disposal of your old product will help to prevent negative consequences for the environment and human health.



Overview

Components

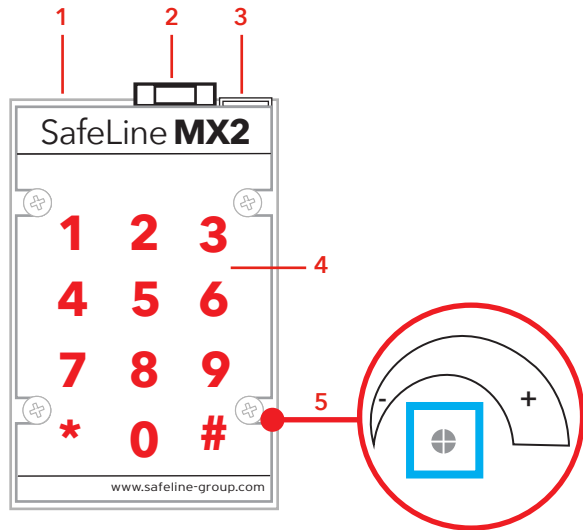

- 1. System LED**
- 2. RJ45 connector.**
Power, emergency button, phone line and auxiliary input.
- 3. RS232 PC connection**
Firmware update and programming with SafeLine Pro.
- 4. Keyboard**
For configuration and line test
- 5. Volume control**
Turn right to increase the volume.

Measurements and components list

Flush mount SafeLine MX2 with pictograms

Article number: *SLMX_Rec-Pic

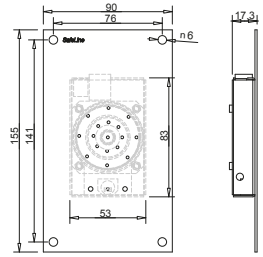

Flush mount SafeLine MX2 with pictograms and emergency alarm button

Article number: *SLMX_Rec-PicB

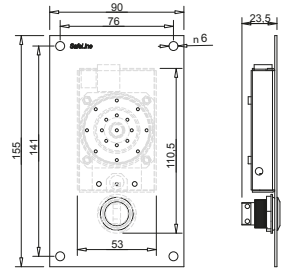

Surface mount Safeline MX2 with pictograms

Cable hole diameter: 8mm

Article number: *SLMX_SM-Pic

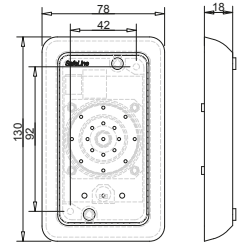

Surface mount Safeline MX2 with pictograms and emergency alarm button

Cable hole diameter: 8mm

Article number: *SLMX_SM-PicB

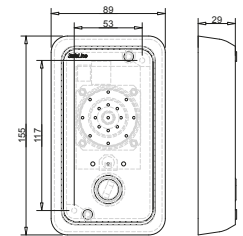

SafeLine MX2 COP

Article number: *SLMX_COP

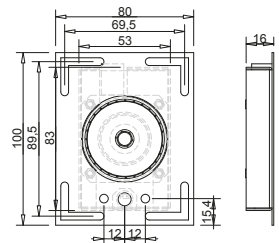

Installation

Wiring diagram

NOTE! Unconnected cables must be isolated, to avoid short circuiting.

Colours when using flat cable

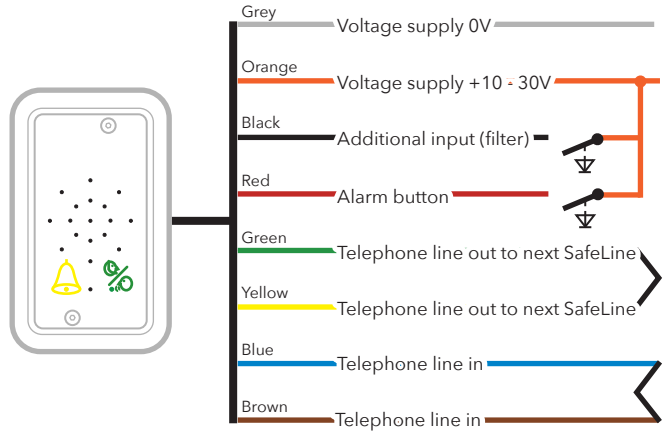

Colours when using round cable

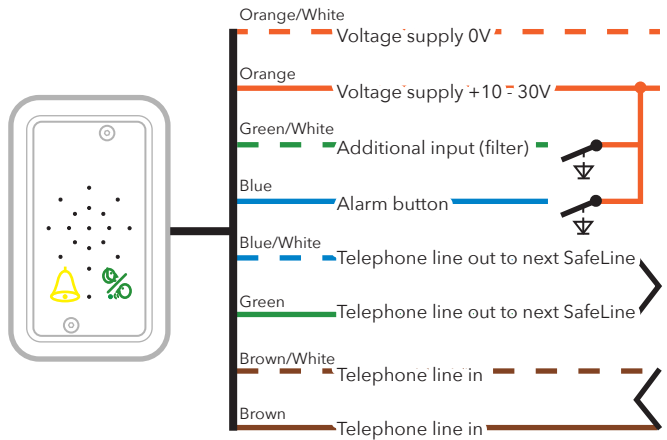

Wiring diagram - PSTN LINE (Max 9 units)

Parallel-wiring

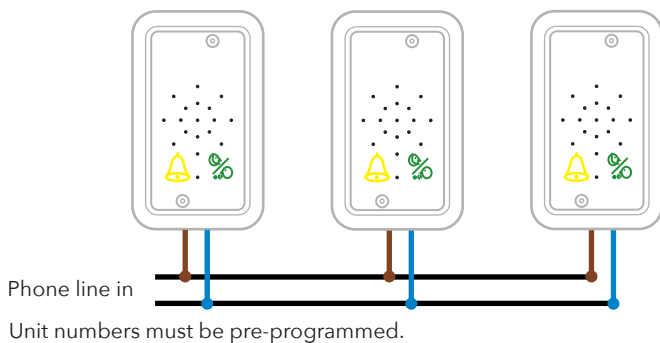

Daisy-chain-wiring (serial wiring)

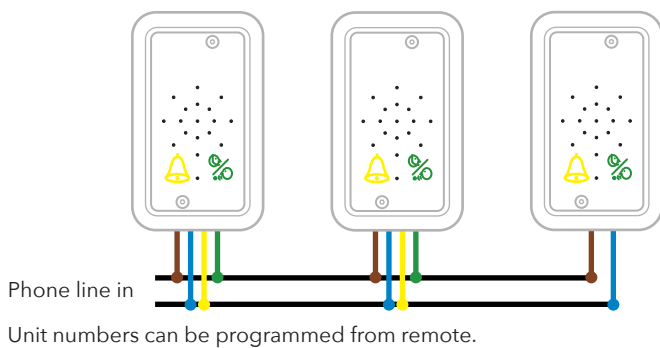

Configuration

Configuration overviews

The unit has to be connected to a power source before the configuration can begin.

Keyboard configuration

The integrated keyboard at the rear of the SafeLine enables a fast programming of the unit.

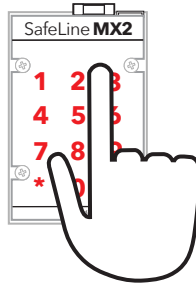

Configuration with SafeLine Pro

The unit can be configured at the office prior to the installation or at site after installation, with a configuration cable (*PCable).

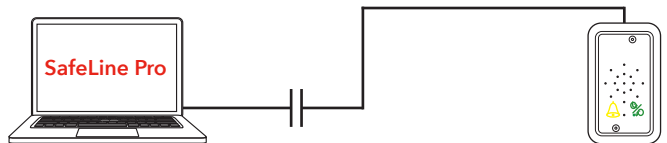

LYNX app

To configure the unit through the LYNX app, the CONNECTable (*CONNECTABLE) is required. Plug in CONNECTable through the unit's serial port and configure the unit through the app just like any other unit.

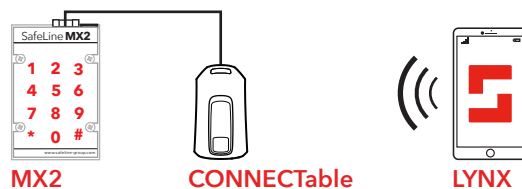

Configuration overviews

The unit has to be connected to a power source before the configuration can begin.

Remote configuration

For remote configuration, you can use any PSTN tone dial phone. Dial the phone number of the SafeLine. Enter the function codes on the phone keypad to start configuration (password has to be entered).

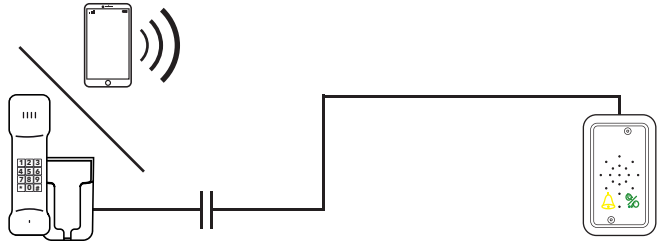

Remote configuration with SafeLine Pro

Connect an SLPro Link to a computer with SafeLine Pro and a serial cable.

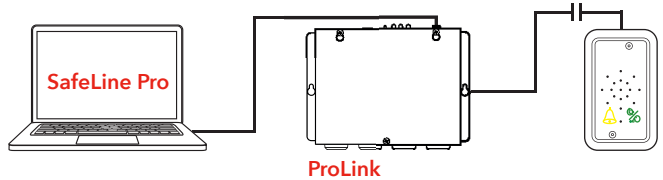

SafeLine Pro can be downloaded on our website:
<http://www.SafeLine-group.com/en/downloads/>
SafeLine Pro 4.42 or later is required.

Configuration method

If the time between the operation of two keys exceeds 10 seconds, the code has to be re-entered. If the time exceeds 30 seconds, the call is disconnected or programming mode is ended.

Remote programming with external telephone

On-site programming using the keyboard

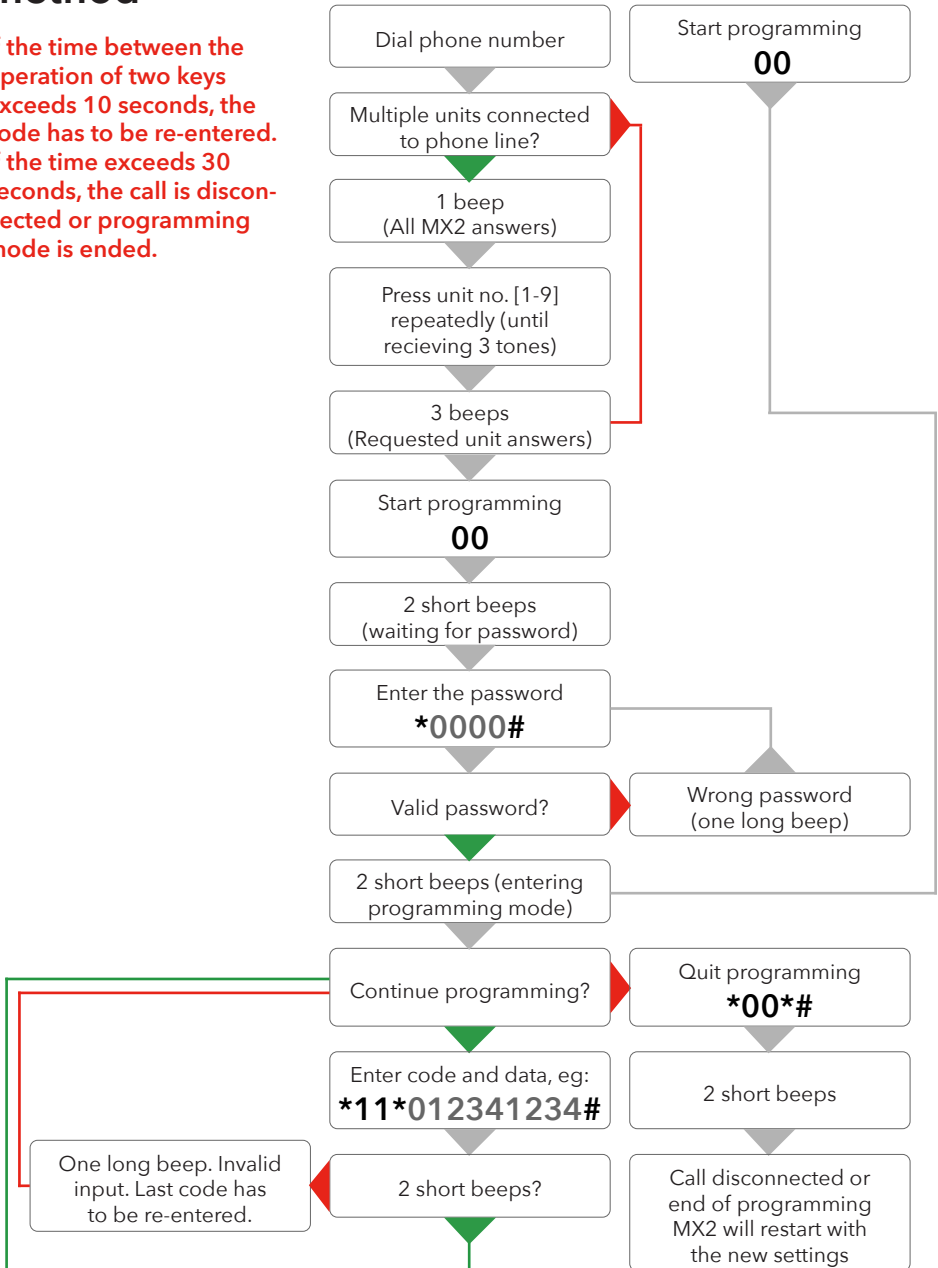

Configuration

Unit numbers

To remotely program a parallel connected unit, the unit number has to be pre-programmed.
If units are connected in series (daisy chain), unit numbers can be remotely programmed.

Remotely program unit numbers in Safelines connected in series:

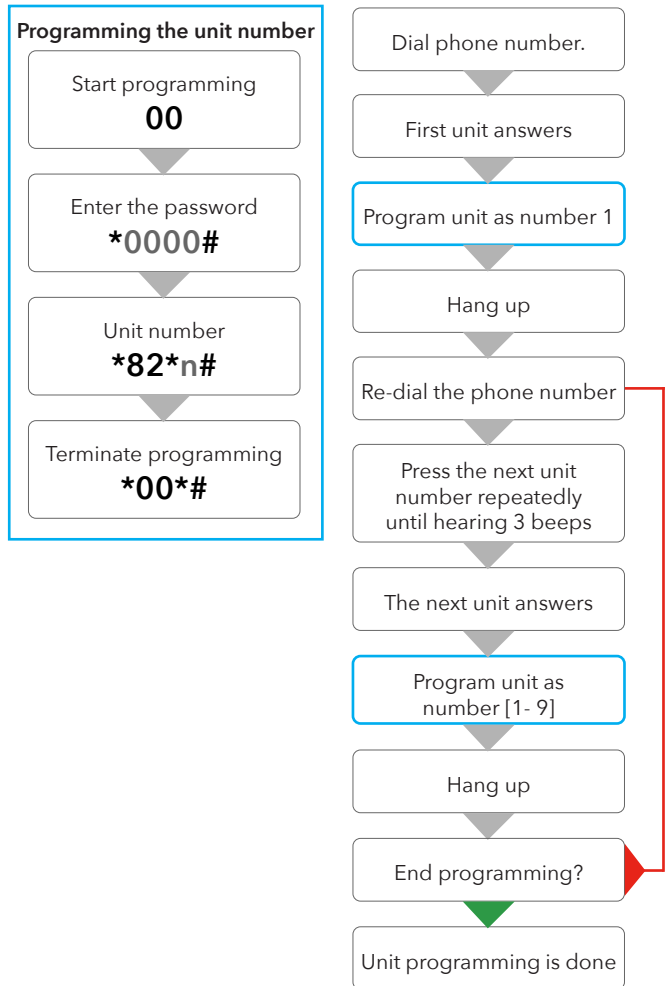

Configuration examples

If at any time you need to start over, use the factory reset command ***99*1#**.

Please refer to the full configuration setup in the "Parameter list" as these are merely examples.

SafeLine emergency telephones

Example 1: Storing of two different telephone numbers, both to be answered as voice calls.

1. Start configuration:

0 0

2. 1st phone number:

*** 1 1 * 1 2 3 4 5 6 7 8 #**

3. 2nd phone number:

*** 1 2 * 2 3 4 5 6 7 8 9 #**

4. Call type 1st number:

*** 2 1 * 1 #**

5. Call type 2st number:

*** 2 2 * 1 #**

6. Alarm button delay:

*** 8 7 * 0 3 #** - Example: 3 seconds delay.

7. End configuration:

*** 0 0 *#**

Configuration examples

If at any time you need to start over, use the factory reset command *99*1#.

Please refer to the full configuration setup in the "Parameter list" as these are merely examples.

Example 2: SLCC (SafeLine Call Centre) and 3-day test.

1. Start configuration:

0 0

2. Enter P100 ID code:

*** 0 1 * 4 5 6 4 5 6 4 5 #**

Lift ID code (each lift must have its own unique code).

3. Set test alarm type:

*** 3 1 * 0 #**

4. Set number of days between test alarm:

*** 2 7 * 0 3 #**

- Example: 3 days between test alarm.

5. LMS phone number:

*** 1 6 * 9 8 7 6 5 4 3 2 #**

(Only if using SLCC)

6. Test alarm:

*** 1 7 * 1 2 3 1 2 3 1 2 #**

(For P100 use telephone number of SLCC, for Caller ID set *31*4# and telephone number of GSM modem)

7. End configuration:

*** 0 0 * #**

Parameter list

Programming data	Code	Data	Comments
Enter programming mode		00	
Enter password		* - - - - #	Default = 0000
Exit programming mode		*00*#	

Alarm codes	Code	Data	Comments
P100 ID code	*01*	- - - - - - #	P100 is always 8 digits
CPC ID code	*02*	- - - - - #	CPC 6-8 digits
Q23 ID code	*03*	- - - - - - - - #	Q23 is always 12 digits

Telephone numbers	Code	Data	Comments
1st Phone number	*11*	- - - - - - - #	Phone number to alarm receiver 0-16 digits. If calling through a switch board, delay time can be set by adding asterisks between leading number of the switchboard and telephone number for the alarm receiver. Each asterisk is equal to one second delay. Example: *11*(0)**1234567#
2nd Phone number	*12*	- - - - - - - #	
3rd Phone number	*13*	- - - - - - - #	
4th Phone number	*14*	- - - - - - - #	

Call type	Code	Data	Comments
Call type 1st number	*21*	- #	Change the call type for the telephone numbers stored. 0 = P100 1 = VOICE (Default) 2 = Q23 3 = CPC Change this only if your alarm operator is using any of the mentioned protocols.
Call type 2nd number	*22*	- #	
Call type 3rd number	*23*	- #	
Call type 4th number	*24*	- #	
Call type LMS number	*30*	- #	LMS (Lift Monitoring System) call type 0 = P100 3 = CPC (Only battery alarm) 4 = Caller ID (Battery powered only)

Test alarm/battery alarm	Code	Data	Comments
LMS phone number	*16*	- - - - - #	LMS (Lift Monitoring System) phone number to alarm receiver/SLCC.
Test alarm	*17*	- - - - - #	Phone number to test alarm receiver/SLCC.
Days between tests	*27*	- - #	Number of days between test alarms, 00-99 days. Always two digits. Max 3 days according to EN 81-28. 00 = No test alarms
Test alarm protocol	*31*	- #	Protocol test alarm 0 = P100 3 = CPC 4 = Phone number used as ID.

Alarm character	Code	data	Comments
Alarm character 1st number	*41*	- - #	Alarm character. only when using CPC as alarm protocol normally 10 or 27 check with your alarm company !
Alarm character 2nd number	*42*	- - #	
Alarm character 3rd number	*43*	- - #	
Alarm character 4th number	*44*	- - #	
Alarm character LMS	*45*	- - #	LMS (Lift Monitoring System) (Battery alarm) Normally 17
Alarm character Test alarm	*46*	- - #	Normally 26

Distress message	Code	Data	Comments
Record distress message played in the lift car.	*51*	"Speak" #	This message will be played in the lift car when the emergency lift telephone starts calling the alarm receiving centre. Make sure that there is no noise in the background when recording the message. Example of message: Please do not panic, the emergency telephone is now calling the emergency call centre.
Record alarm message from Lift Car to alarm central	*52*	"Speak" #	This message will be played to the alarm receiver and in the car when the call is answered. Make sure that there is no noise in the background when recording the message. Example of message: This is an alarm from the lift on 5th avenue. To hear this message again, press "1". To terminate the call, press "#" before hanging up.
Options for the recorded distress message	*61*	- #	0 = Disable recorded message. 1 = Enables recorded message.
	61	#	Play the the recorded message.
Options for the recorded message from lift car	*62*	- #	0 = Disable recorded message. 1 = Enables recorded message.
	62	#	Play the the recorded message.

Other codes	Code	Data	Comments
Emergency signal in speaker	*71*	- #	The speaker siren will sound at emergency call. 1 = On 0 = Off (Default)
Ring tone timeout	*72*	-- #	Number of ring signals before dialling the next number. (8 by default)
Additional input function	*73*	- #	Selects input function: 0 = None (Default) 1 = Filter, blocks the alarm input when active. 2 = LMS (Lift Monitoring System), sends a lift monitoring alarm at input activation. 3 = Clear/Maintenance
Additional input type	*74*	- #	0 = Normally-open contact, NO (Default) 1 = Normally-closed contact, NC
Hot Line	*75*	- #	Phone connects directly to a fixed recipient without dialling a phone number 0 = Standard phone line (Default) 1 = Hotline
Indicator mode	*78*	- #	0 = Standard, 1 = Strictly EN81-28 2 = Strictly single EN81-28
Voice communication time-out	*79*	- #	1 - 20 minutes xsxs. Standard = 8 min
Reset active alarm automatically	*80*	#	0 = OFF, 1 = ON (Default)
Auto answer	*81*	-- #	No of signals before SafeLine answers incoming call. Can be set from 00-16 (Default = 02, 00=Unit will not answer).
Unit number	*82*	- #	Program Unit number 1-9 (Default = 0)
Detect dial tone	*83*	- #	0 = Off 1 = On (Default) Set to off if SafeLine has problem to detect the dial tone.
Receipt to alarm receiver with P100 protocol	*84*	- #	Select which message(s) to send to the alarm receiver at an alarm call. 0 = None (Default) 1 = Start of alarm 2 = Start+end of alarm
Break on new alarm	*86*	- #	Disconnects a call longer than 60 seconds at new activation of the alarm button and calls the next emergency call number. 0 = OFF 1 = ON (Default)
Alarm button delay time	*87*	-- #	Delay time from pressing the alarm button until activating the alarm. 00-25 seconds. (Default = 05)

Other codes	Code	Data	Comments
Alarm button type	*89*	- #	0 = Normally-open contact, NO (Default) 1 = Normally-closed contact, NC
Change password	*91*	- - - #	Change password (default=0000)
Simulate an alarm event	*94*	- #	Triggers an alarm event after programming is terminated. 1 = Emergency call 2 = Test alarm 3 = Battery failure 4 = Microphone/Loudspeaker failure 5 = Receipt on voice call 6 = Maintenance 7 = Main unit power failure 8 = Stuck button alarm
Reset to default settings	*99*	- #	1 = Factory default 2 = Default P100(The following codes will be set): *21*0#, *22*0#, * 27*03#, *80*1#, *84*1# 3 = Default CPC(The following codes will be set): *21*3#, *22*3#, *27*03#, *80*1#, *84*1# 4 = Default VOICE(The following codes will be set): *21*1#, *22*1#, * 27*03#, *80*1#, *84*1#
Compatability mode	*77*	- #	0 = Automatic voice switching The call is validated when there is a voice response. The call is terminated by pressing "#". 1 = Kone ECII (lift telephone) When there is a voice response, some ascending tones will be heard. The call is validated by pressing "4". The call is terminated by pressing "0". The call is terminated without receipt notification by pressing "2"(the unit will call the next number). 2 = Manual voice switching When there is a voice response, some ascending tones will be heard. The call is validated by pressing "4". Unit is still in automatic mode. To enter manual mode and talk press "*". To listen press "7". Go back to automatic mode press "4". The call is terminated by pressing "#". It is possible to enter manual voice switching mode although the unit is programmed as automatic by pressing "*". No ascending tones will be heard. For repeating the voice message, press "1" in all modes.

Operation

LED indication for pictogram in car



Yellow LED

Call in progress
The yellow pictogram LED is lit as soon as the alarm button is pressed.



Green LED

Call connected
The green pictogram LED turns on as soon as the SafeLine unit detects a responding voice. The LED is turned off when the call is terminated.



System LED

The system LED is located on the back-side of the unit.

Standard (*78*0#)

Light off

Yellow LED

No alarm activated
Flashing once every 5 seconds
Telephone line not OK.

Green LED

Telephone line not OK.
Flashing once every 5 seconds
Unit is OK.

System LED

Flashing once every 5 seconds:
Telephone line OK.

Flashing quickly

Flashing twice every second
Alarm button active.

Flashing two times every 5 seconds
Alarm filter activated.

Flashing two times every 5 seconds:
No telephone connection available.
Flashing rapidly:
Incoming call.

Continuous light

Activated alarm.
Remains lit until reset.

Call connected.

Call connected.

Strictly EN81-28 (*78*1#)

Flashing

Flashing twice every second
Alarm button active.

Green LED

Call connected.

Continuous light

Activated alarm.
Remains lit until reset.

Test alarm failure

Yellow LED

Light on for 1 second then light off for 1 second

Test alarm (line check) failed
Returns to normal at next valid test alarm.

Green LED

Test alarm (line check) failed
Returns to normal at next valid test alarm.

Testing

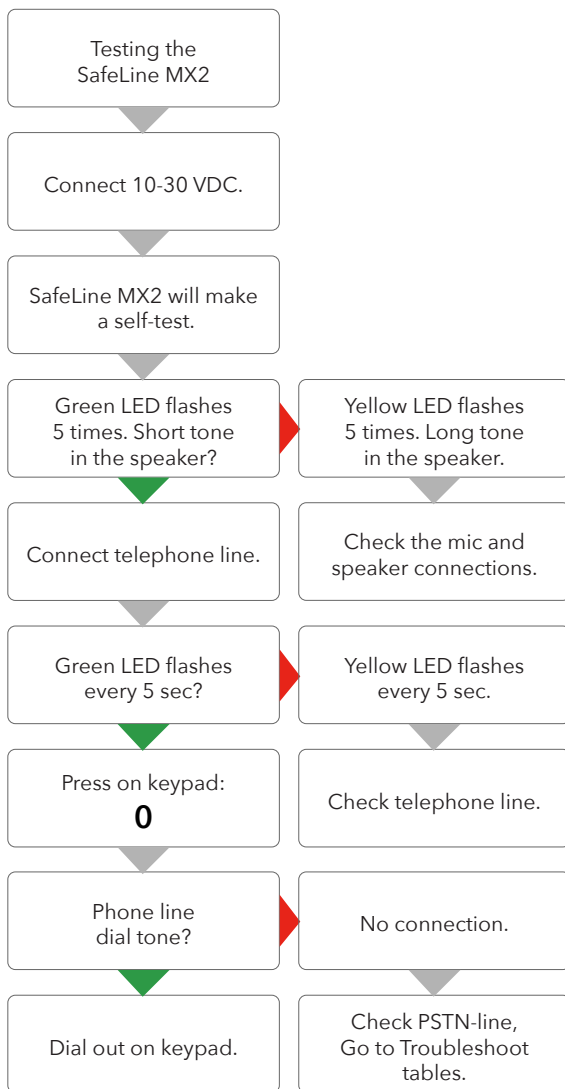

Emergency calling process

Maximum 12 calls: with 4 stored telephone numbers, each number could be called 3 times. This adds up to the 12 call limit. To restart the dialling process, another push of the alarm button is needed.

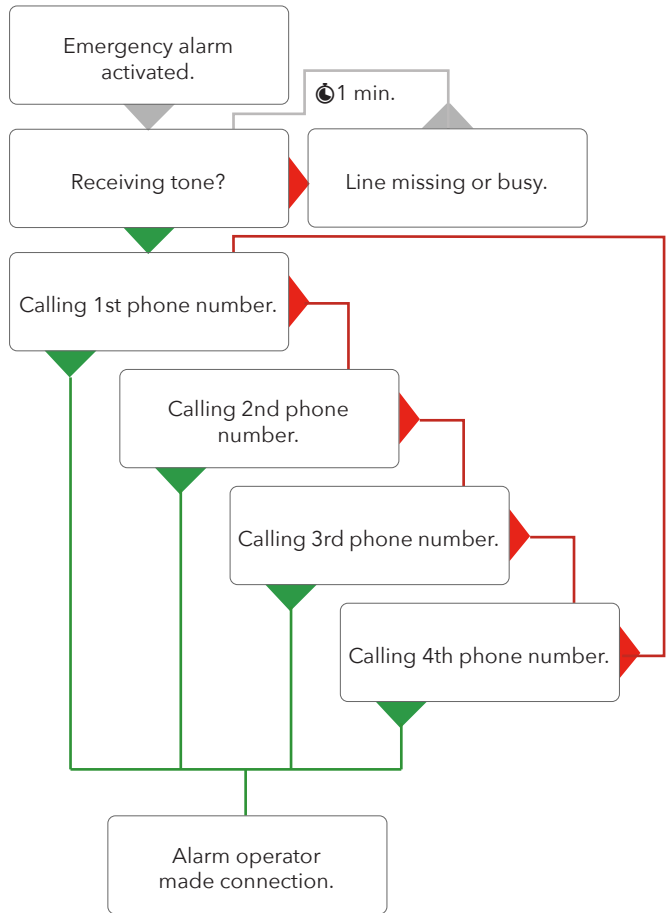

Trouble-shooting

Emergency button N/O



Emergency button N/C



The telephone beeps every 5 seconds.

This is to notify the passengers of the ongoing call (anti eaves dropping)

The unit makes an alarm call when powered up.

- Improper type of emergency button selected. Change from NC to NO or from NO to NC.
- Emergency button is stuck.

No sound transmitted from the lift car to the call receiver

Press "0" to get an outside line. Make a call. If the sound transmission is OK in both directions, check if your emergency operator supports the chosen alarm type. If no protocol is used, change the call type to "VOICE". If no sound is transmitted from the lift car, check the microphone.

Poor/distorted sound quality

Volume might be set too loud! Lower the volume and check again.

Interfering noise when the call is connected

The problem might be due to induction in the phone cable. According to the phone companies' regulations, the phone line must be installed in a separate cable.

GSM noise

Change the antenna position when a call is connected until you find the optimal antenna position. Do not install the antenna near the unit or close to the cabelling.

Can not dial out

- Broken line connection. (LED not blinking green)
- No money on prepaid SIM-card, verify the SIM-card by inserting it into a normal mobile phone.

No voice switching

- The volume is set too high.
- The problem might be due to induction in the phone cable.

The unit can not make an alarm call.

At least one phone number (and one ID code if using data identification) must be programmed to enable making a call from the unit. Refer to the parameter list (*11*).

EU Declaration of Conformity

Product: Lift telephone
 Type / model: **SafeLine MX3**
 Article no: *SLMX3-COP, *SLMX3-COP2, *SLMX3-LENS90, *SLMX3-REC-PIC, *SLMX3-REC-PICB,
 *SLMX3-SM-PIC, *SLMX3-SM-PICB, *SLMX3-SMD-PICB, *RU-SLMX30005
 Manufacturer: SafeLine Sweden AB
 Year: 2020

We herewith declare under our sole responsibility as manufacturer that the products referred to above complies with the following EC Directives:

Directives

Radio Equipment (RED):	2014/53/EU
RoHS 2:	2011/65/EU

Standards applied

EN 81-20:2014	Lift: Safety & Technical requirements
EN 81-28:2003	Lift: Remote alarm on passenger and goods passenger lifts
EN 81-70:2003/A1:2004	Lift: Accessibility to lifts for persons including persons with disability
EN 12015:2014	EMC: Emission, Electromagnetic compatibility
EN 12016:2013	EMC/Lifts: Immunity, Electromagnetic compatibility
EN 62368-1:2014/AC:2015	LVD: Information Technology Equipment
EN 50581:2012	RoHS: Technical doc. for assessment of restriction of RoHS.
TBR21/CTR21	PSTN Terminal equipment

For RED 2014/53/EU, the conformity assessment procedure "Module A" used as described in Annex II. Accordingly, respective manufacturer has done the radio modules conformity assessment:

Standards applied	Article of Directive 2014/53/EU
-------------------	---------------------------------

EN 60950-1:2006+A11:2009+A1:2010+A12:2011	3.1 (a): Health and safety of the user
EN 62311:2008	
EN 301 489-1 v2.1.1 + EN 301 489-52 v1.1.0 Draft	3.1 (B): Electromagnetic Compatibility

Module	Notified body	Address	NB nr	Test nr
CYW207325	NTS Silicon Valley	41039 Boyce Road, Fremont, CA 94538, US	0214.26	R 104750/51

EN 301 489-17 V3.1.1	
EN 300 328 V2.1.1	3.2: Effective use of spectrum allocated

Firmware used during assessment

SafeLine MX3:	1.00
---------------	------

Tyresö, 2020-02-05



Lars Gustafsson,
 Technical Manager, R&D , SafeLine Group

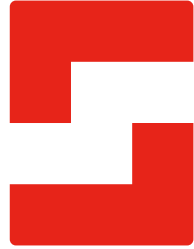

SafeLine Headquarters

Antennvägen 10 · 135 48 Tyresö · Sweden
Tel.: +46 (0)8 447 79 32 · info@safeline.se
Support: +46 (0)8 448 73 90

SafeLine Denmark

Vallensbækvej 20A, 2. th · 2605 Brøndby · Denmark
Tel.: +45 44 91 32 72 · info-dk@safeline.se

SafeLine Norway

Solbråveien 49 · 1383 Asker · Norway
Tel.: +47 94 14 14 49 · post@safeline.no

SafeLine Europe

Industrieterrein 1-8 · 3290 Diest · Belgium
Tel.: +32 (0)13 664 662 · info@safeline.eu
Support: +32 (0)4 85 89 08 95

SafeLine Deutschland GmbH

Kurzgewannstraße 3 · D-68526 Ladenburg · Germany
Tel./Support: +49 (0)6203 840 60 03 · sld@safeline.eu

SafeLine Group UK

Unit 47 · Acorn Industrial Park · Crayford ·
Kent · DA1 4AL · United Kingdom
Tel.: +44 (0) 1322 52 13 96 · info@safeline-group.uk

SafeLine is a registered trademark of SafeLine Sweden AB. All other trademarks, service marks, registered trademarks, or registered service marks are the property of their respective owners.